

Product- & Solutions Datasheets

Content

Welcome to Medialine! 4

IT Security & Services 8

Managed Vulnerability Scan - MVS	9
mailDefend	10
VMware Health Check Service	11
Security Awareness Training	12
Security Awareness Prozess	13
Security Workshop in a Box	14
Veeam Cloud Connect	15
ITQ Basic Examination	16
ITQ Cybersecurity Analysis	17
ITQ Infrastructure Analysis	18
ITQ Ransomware Checkup	19

Business Continuity 20

Managed Monitoring	21
Cloud Disaster Recovery	22
E-Mail Schutz und Backup für M365	23
Managed Service Endpoint	24

Datacenter 25

VMware vSAN 7.0	26
VMware NSX	27
Managed Kubernetes	28
Object Storage as a Service	29
Managed Inventory	30

Modern Workplace 31

Backup für Microsoft Office 365 Anwendungen	32
Administration (AaaS) und Monitoring (MaaS) von Microsoft 365 Anwendungen	33
Medialine UEM Mobile	34
Medialine Unified Endpoint Management	35
WiFi as a Service	36

Cloud Computing 37

Cloud SAP IaaS auf der CompanyCloud	38
CompanyCloud Self Service Portal	39
Managed Mail Archive	40
Hosted Exchange	41
Dataport	42
Azure Peering im Medialine Dataport	43

Business Software 44

Boxxer ERP	45
Boxxer POS	46
Mesonic Winline	47
WinLine/cop Integration	48
eProcurement	49

Unified Communications 50

ITK SIP-Trunk	51
ITK Teams Solution	52
Microsoft Teams Solution	53
Microsoft Teams Consulting	54
ITK Presence Hub	55
Cloud Telephone Systems	56
Video conference rooms & systems	57

Our locations in Europe 58

Welcome to the Medialine Group! 59



Welcome to Medialine!

About us

As one of the leading IT system houses, we support customers from medium-sized companies to large corporations across all industries. With our premium services, we offer 360-degree IT support according to our guiding principle of „Any Place – Any Time – Any Device – Any Application“. In a fast-paced, agile, and challenging business world, we see powerful, secure, and flexible information technology as a decisive competitive advantage for our customers and our responsibility. Highly specialized teams manage the Medialine solution portfolio in the areas of IT infrastructure, managed & cloud services, and business solutions.

Since 1999, we have distinguished ourselves through excellent service, a comprehensive innovative offering, and outstanding references. With a tightly knit network of locations in Germany, branches in neighboring European countries, and several redundant data centers, we continue to be on a growth trajectory.

As a Dell Technologies Titanium and Microsoft Gold Partner, as well as a VMware Solution Provider and Business Partner of Telekom Deutschland, we work with strong partners for our customers. We deliver a complete portfolio of managed IT services from our own data center with our product „CompanyCloud.“ In recent years, we have received numerous awards that have strengthened us on our path. For example, we were honored as „Best Managed Service Provider“ and „Best Enabler Digital Transformation“ by COMPUTERWOCHE and ChannelPartner, respectively and were awarded the „Best System House in Germany“ distinction twice in a row.

We are excited to introduce you to our comprehensive solution expertise.

It's a Match - Our Portfolio for Your Needs

With our comprehensive, carefully curated portfolio, we offer customers holistic IT services from a single source: from classic hardware and infrastructure offerings to business software solutions and our cloud & managed services, which form the heart of our company, we are your go-to partner. We see continuous development and innovative portfolio design as important building blocks for our success and yours.

Get started now - with IT services that fit your needs

From our own data centers in Austria, Romania, and Germany, we provide a complete portfolio of managed IT services with our CompanyCloud. This means that you can also receive all the components of our portfolio as managed services.

Strong partnerships with renowned manufacturers and highly specialized expert teams make us the right partner for your requirements, whether you are looking for a specialized individual solution or planning a holistic outsourcing project.

A selection of our partners

In the successful implementation of your customer projects, we have numerous long-standing partners by our side. Thus, we are able to reliably and future-proof tackle any IT challenges your business may face.



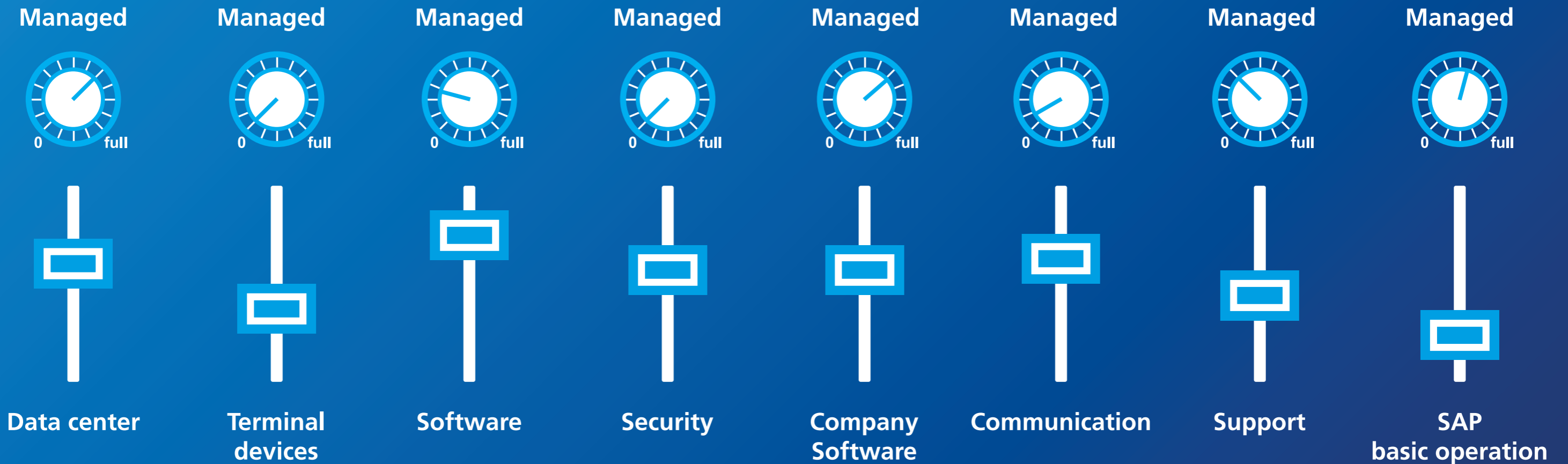

360-degree IT - tailored to your needs and all from one source!

The individual requirements and circumstances of each of our customers are different. Business areas, organizational structures, own skill levels, and personnel strength in the IT environment vary greatly from company to company. Individuality is therefore crucial! We tailor our offerings and services to fit your needs optimally. Which and how many of our services you want to use is up to you - as is the decision of which services you want to operate on-premises yourself or use as managed services.

We are pleased to present you with an excerpt of our portfolio with this collection of data sheets.

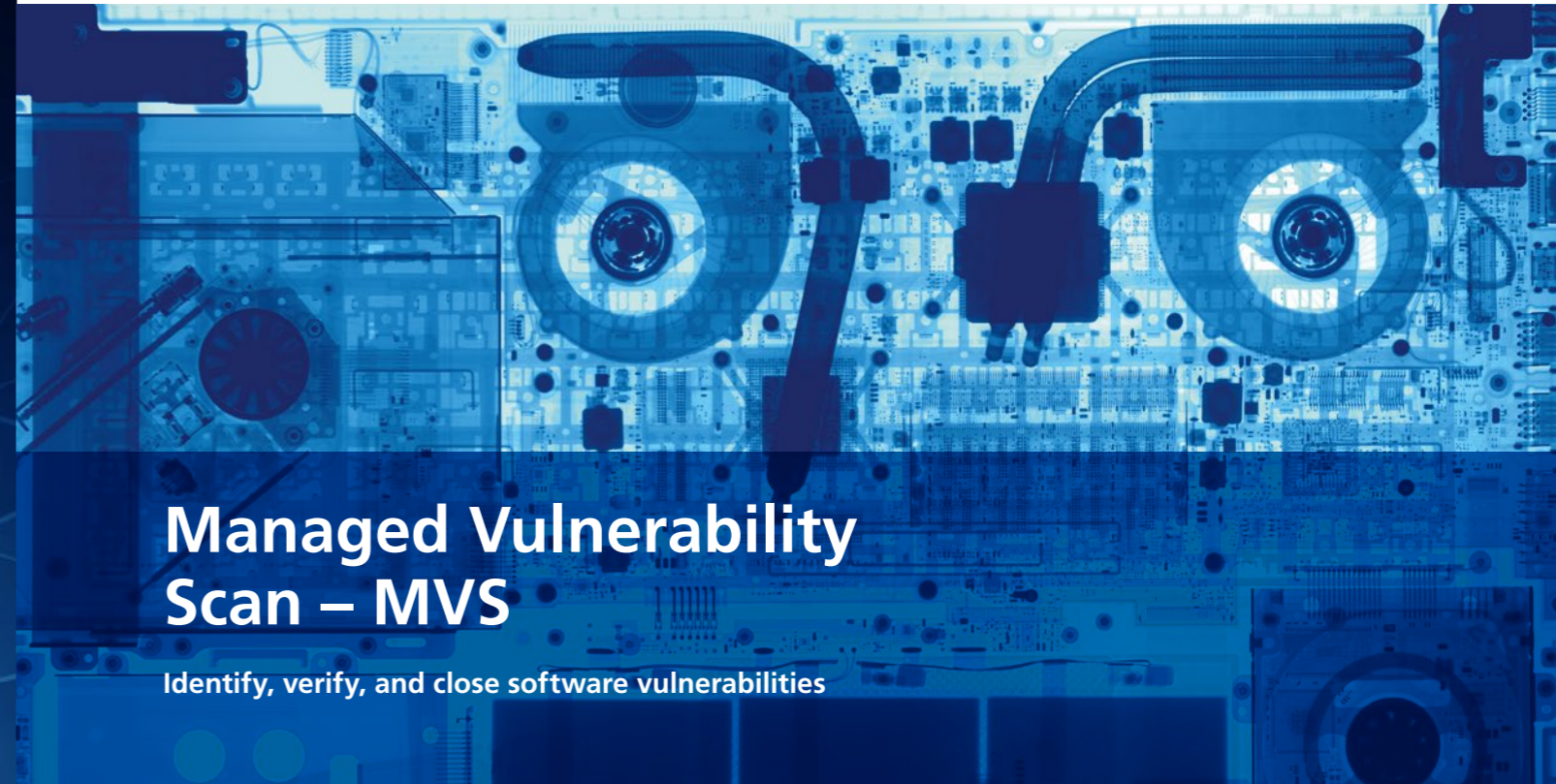

Managed Vulnerability Scan – MVS

Identify, verify, and close software vulnerabilities

Software vulnerabilities are popular entry points for attackers. Lack of updates, outdated software versions, or simply a lack of knowledge in setting up or securing systems can provide attackers with countless ways into your infrastructure.

Once in, they can quickly infiltrate sensitive areas, steal business secrets, access customer data, take over online banking, and encrypt all data including backups. The economic and image damage could not be greater, and it is not uncommon for such attacks to threaten the existence of damaged companies. Protect yourself before the crisis occurs! With our Managed Vulnerability Scan, we help you protect your applications and systems from threats and efficiently minimize the risks of cyber-attacks.

What we offer

Whether a one-off scan or regular security updates, the Managed Vulnerability Scan uncovers weaknesses and helps you to improve the security level of your infrastructure sustainably and continuously.

Configure your individual Managed Vulnerability Scan to suit your infrastructure:

Scan-Type

- Scan S – up to 100 IP addresses
- Scan M – up to 250 IP addresses
- Scan L – up to 1000 IP addresses
- Scan XL – over 1000 IP addresses

Timeframe

- 1 year
- 3 years

Reporting

- quarterly (basic),
- monthly (premium)



IT Security & Services





mailDefend

Medialine Managed Mail Security
maximum spam protection - maximum security - no administrative effort

E-MAIL
SECURITY

HOW IT WORKS

VMware Health Check Service

Performance, Stability, and Availability for Your IT Infrastructure

Why Managed Mail Security? Receiving no unwanted or harmful emails on your own mail server is the obvious and simple benefit of a spam filter. Medialine's mailDefend offers much more. The main advantages at a glance:

Transparency and Control

With Medialine mailDefend, you determine the conditions for the email communication of your company. With maximum transparency and maximum control, you meet the requirements for modern communication within and outside the company - compliant and secure.

User-friendly and simple

For users, it is important that the operation of the spam filter service is as time-saving and simple as possible and that they are not pulled out of their daily work routine. mailDefend saves users the time-consuming task of deleting unwanted emails and ensures easy operation of the services.

Backup and Storage

With a false-positive rate of less than 0.00015 per clean mail, mailDefend ensures that the right messages land in your inbox. If your mail server is not accessible, incoming emails will be held for up to 7 days for the recipient and delivered automatically when it becomes accessible.

High availability and archiving

With the optional Continuity Service, users can continue to receive and send emails even if their mail server fails. The additional archiving service includes the tamper-proof storage of all incoming and outgoing messages.

Are you unsure if your VMware environment is up to date? Do you want to make sure you are using your infrastructure to its fullest potential and desire a personalized analysis? Then our Health Check Service is right for you.

Overview

We, Medialine AG, offer you a combination of workshop and IT infrastructure analysis with the proven VMware Health Check. Using best practices established by VMware, our certified consultants will analyze your environment and provide helpful recommendations for improving performance, stability, and availability.

Find answers to your questions

- During the health check, you will receive answers to questions such as:
- Is my environment up to date?
- What is the risk of failure?
- Is the environment in compliance with manufacturer recommendations?
- Is my hardware configuration supported?
- How can performance be improved, etc

Main advantages

- Optimization of vSphere performance
- Maximization of stability
- Reduction of risks due to configuration errors

You will receive

- A comprehensive written analysis of the condition of your VMware infrastructure
- Examination results of the configuration of your ESXi servers
- Information on the efficient use of VMware products and add-ons you have acquired
- A template-ready documentation of the condition of your virtual infrastructure
- Suggestions for optimization, expansion and possible upgrades
- Specific recommendations for optimizing your infrastructure





Security Awareness Training

Strengthen the human firewall with the employee security index



Security Awareness Process

Cyber attacks have existential consequences for companies

Social engineering manipulates people into giving out information they shouldn't, downloading unauthorized software, or visiting websites with harmful content.

Criminals use social manipulation to influence their victims to divulge information, provide funds, or make other mistakes that deliberately bypass a company's security measures and cause significant harm. Since social engineering exploits human traits and weaknesses, cybercriminals use sophisticated psychology and tactics to obtain personal information such as login details, bank accounts, or credit card numbers.

Hornetsecurity's Security Awareness Training trains employees through realistic spear-phishing simulations and AI-supported e-training, sharpening their awareness of cyber security risks and threats.

Security Awareness Training that motivates and is fun:

- Consulting and individual customization of the training dashboard to the respective company structure offered by Medialine, upon request
- Interactive E-Trainings: Flexible implementation of the trainings - in one session or in several sessions.
- Short videos: Practical illustrations that address the motivation of learners
- PDF files: Supporting information for quick access
- Memo-rays: Summary of previously completed trainings
- Quizzes: Quick-checks for knowledge assessment

Employees are considered to be the weakest link in a company's IT security concept. That is why they are the first victims of attacks and thus the door opens into corporate IT.

The Medialine Cyber Security Awareness Process was designed and developed to address this challenge. It serves as an effective method to increase employees' security awareness. It also helps to implement a sustainable security awareness strategy in companies and internalize and increase awareness of various security risks among all those involved. As security awareness of employees is heightened so too is the extent of their own security responsibility. Through the Cyber Security Awareness Process, employees are no longer a risk, but become a critical part of the IT security concept.

Cyber Security Awareness Process Flow

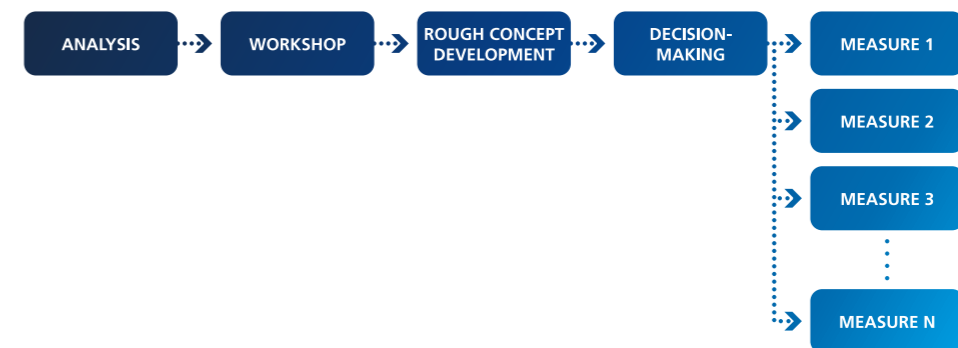

Security Workshop in a Box

Do the security check: modular - goal-oriented - budget-friendly

Safe is not safe enough

»Security Workshop in a Box« is a service product offered by Medialine AG. The aim of the workshop is to show you areas in which there is still a need for action in your IT security. „Security Workshop in a Box“ contains various conversation guidelines and templates, with which our technical staff, together with you, will examine your IT security and determine the need for action. We will show you precisely what IT security risks exist in your company and offer solutions that will make your IT more secure.

The workshop is modular in design. This means that you decide which aspects of your IT security should be considered. In this way, you have direct influence on how much you want to invest in the IT security of your company. Each module has a time key. The total effort per module is calculated by adding the times. Each module includes the following content: tasks, questions for the customer, times, and results.

Objective

The questions are intended to assess to what extent you have already thought about IT security and whether certain requirements have already been fulfilled. For questions that require documentation, it may be useful to review some of these documents together. This can serve two purposes: firstly, to verify whether the documentation is up-to-date or whether there is a need for redesign, and secondly, to create such documentation early on if it does not yet exist (after consulting with you).

Veeam Cloud Connect

Are you looking to set up a second backup location?
Do you need to invest in new hardware to do so?

Solve these structural problems easily with Veeam Cloud Connect in the new Availability Suite 8 from Veeam. Use the backup repository in the Medialine Company- Cloud to add extra security to your backup. Choose Medialine AG as your certified service provider directly in the Veeam software and pay only for the storage you need. Avoid the risk of catastrophic data loss by connecting to our backup repository. This is the easiest and most efficient method for storing backups in the cloud.

Benefits

Hosting external backups

Move your backups externally to the Company-Cloud repository via a reliable, secure SSL connection and a Veeam Cloud Gateway without additional licensing requirements.

Complete transparency and control

Access and restore data in the hosted backup repository directly through the backup console. Track usage of the CompanyCloud repository and receive notifications when updates are due for your hosted environment.

Modern backup architecture

Optimize Veeam backup technology with backup copy jobs and integrated WAN acceleration, unlimited incremental backups, GFS retention policies (Grandfather-Father-Son), and much more to comply with the „3-2-1 rule“ - all with just one product.

End-to-end encryption

Encrypt your data at the source (before leaving your network environment) without negatively impacting the data compression rate of integrated WAN acceleration.





ITQ Basic Examination

Measuring Information Security Effectively

ITQ Cybersecurity Analysis

Comprehensive Assessment, Transparent Results, Sustainable Security Solutions

In the fast-paced digital era, relying on a perceived sense of IT security is no longer sufficient to tackle the diverse and constantly evolving threats. To ensure comprehensive and demonstrable IT security, it is crucial to rely on objective metrics.

Our ITQ Basic Examination was designed to meet this specific need. Through collaboration with a TÜV-certified IT Security Auditor and Compliance Manager, we provide businesses with a solid foundation for identifying vulnerabilities in both technical and organizational aspects, enhancing the security and availability of their systems, and creating a robust basis for IT investment planning.

This Basic Examination goes beyond being a mere audit; it serves as a strategic tool that empowers management to identify, understand, manage, and monitor necessary IT measures effectively.

ITQ Basic Examination in a nutshell:

- Identification of vulnerabilities in both technical and organizational areas.
- Enhancement of the security and availability of technical systems.

- Assurance of organizational and personnel infrastructure.
- Establishment of a foundation for IT investment planning.
- Validation of IT security through external assessment.
- Mitigation of IT risks and liability for IT executives and managing directors.
- Conducted by a TÜV-certified IT Security Auditor and Compliance Manager.
- Evaluation of the IT basic protection concept on-site.
- Tailored IT audit based on BSI basic protection.
- Available audit versions: ISA – ITQ – ISO 27001 – BSI

The ITQ Cybersecurity Analysis is a robust tool for conducting a thorough examination of information security. It employs a detailed checklist-style audit catalog to evaluate technical and organizational requirements across more than 2,000 checkpoints.

Flexible Audit:

- A modular audit structure that allows for flexible adjustments.
- The option to duplicate or exclude specific objects, such as when assessing multiple firewalls.

Presentation of Results:

- The results are presented visually in a high-quality final report.
- This report spans over 100 pages and offers a comprehensive analysis of the client's security status.

Advantages of the Approach:

- Comprehensive examination of all pertinent information security aspects.
- A high-quality analysis to ascertain the client's security status.
- An informative and visually appealing results report.
- Detailed checklists for system setup and installation.
- A significant potential for subsequent orders and ongoing support.
- Compliance with information disclosure obligations to the client.





ITQ Infrastructure Analysis

Effective Optimization: Keeping a Watchful Eye on Your IT Infrastructure with ITQ



ITQ Ransomware Checkup

Enhancing Digital Resilience: ITQ Ransomware Protection Assessment for Your Business

The IT infrastructure serves as the cornerstone of modern enterprise IT systems. The ITQ Infrastructure Analysis is a robust tool designed to help organizations conduct a thorough assessment and streamline their IT infrastructure and processes.

What Does the ITQ Infrastructure Analysis Entail?

The ITQ Infrastructure Analysis enables precise inventorying of a customer's infrastructure and processes. By consolidating all pertinent information about individual systems and applications, it generates a clear report that serves as a foundation for targeted optimization efforts.

Prevention and Response:

The execution of measures is overseen through an extensive examination. Customers receive a detailed final report containing results and practical implementation guidance. This approach allows for swift comprehensive inventories, automated textual outputs for each checkpoint, and enhanced transparency before new customer support begins.

Advantages of This Approach:

- **Swift Inventorying:** Comprehensive analysis of corporate infrastructure.
- **Automated Textual Outputs:** Efficient reporting for every checkpoint.
- **Pre-Support Transparency:** Clear insights into the infrastructure before support begins.
- **High-Quality Results Report:** Featuring diagrams and visuals for better comprehension.
- **Comprehensive Consultation Framework:** Serving as the basis for comprehensive customer guidance.
- **Tailored Proposals:** Formulated based on the analysis to offer optimal customer support

Ransomware poses a significant threat to businesses by encrypting files and demanding ransom for decryption. The ITQ Ransomware Protection Assessment provides a comprehensive evaluation of your defenses against this perilous form of cyber threat.

Prevention and Response:

The Federal Office for Information Security (BSI) recommends specific protective measures to minimize the risk of ransomware infection. The ITQ Ransomware Protection Assessment checks compliance with these measures in an audit examination. Customers receive a final report with results and guidance on implementation.

Advantages of This Approach:

- **Cost-Effective Assessment:** Evaluation of your own ransomware protection measures.
- **Liability Mitigation:** Proof of compliance with due diligence.
- **Detection of Unidentified Risks:** Early identification of potential threats.
- **Guidance for Security Measures:** Enhancing the level of protection.
- **Measurable Outcomes:** Clear risk assessment at the end of the examination.
- **Planned Budget Allocation:** Allocation of IT budget based on risk assessment.





Cloud Disaster Recovery

Professional administration and monitoring of your IT environment



Email Protection and Backup for M365

Your insurance with Hornetsecurity

Your emergency data-center safety net. By using our recovery services, you can avoid costly investments in your own backup data center and activate your virtual emergency data center only when necessary, at Medialine AG's data centers in Germany.

Cloud Server Replication

Server-replication for VMware or MS Hyper-V customer data-center.

The service creates a copy of the customer's virtual system as a bootable image in a cloud data center.

The service is charged per customer host system and per customer virtual machine (VM). The customer is also required to book the necessary storage space in the data center for the image to be stored as a productive storage area network (SAN) storage.

In case of a disaster, resources can be booked through the on-demand service computing to boot the virtual servers. This requires booking the on-demand service in conjunction with virtual server replication. No replication VM installation is required on the customer side.

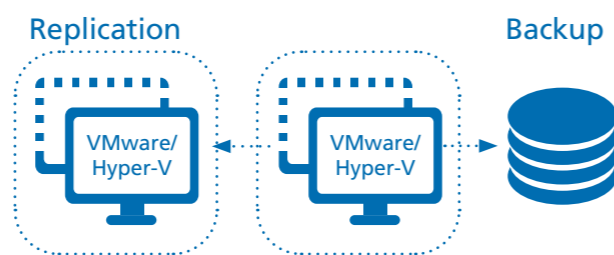

Are you still receiving a lot of spam messages or spending a long time searching for archived emails? Protect your business email communication with 365 Total Protection. But which solution is right for me?

Topic	Microsoft	Hornetsecurity
Guaranteed spam detection rate (SLA)	99%	99.9% spam 99.99% virus detection

Number of unknown spam emails, per detection rate for 1,000,000 received emails.

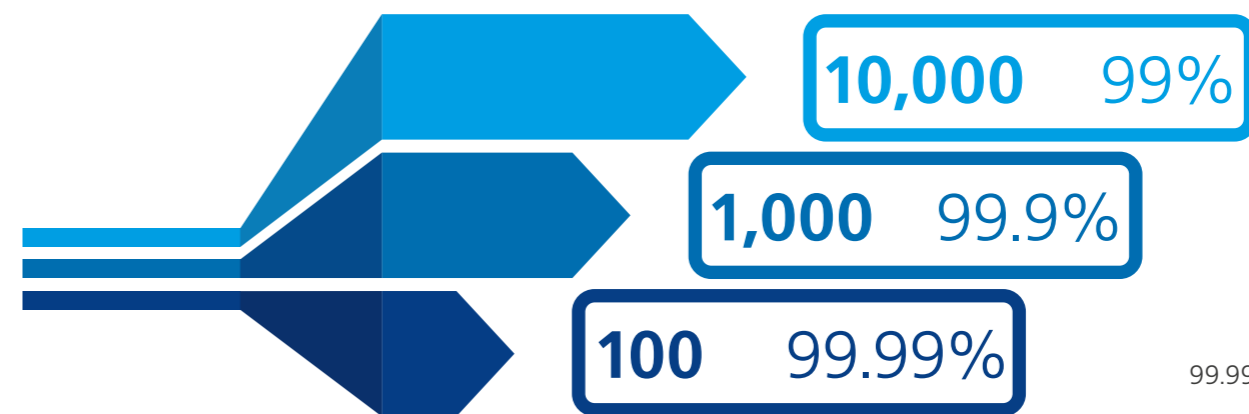

99.99% spam filter rate by Hornetsecurity



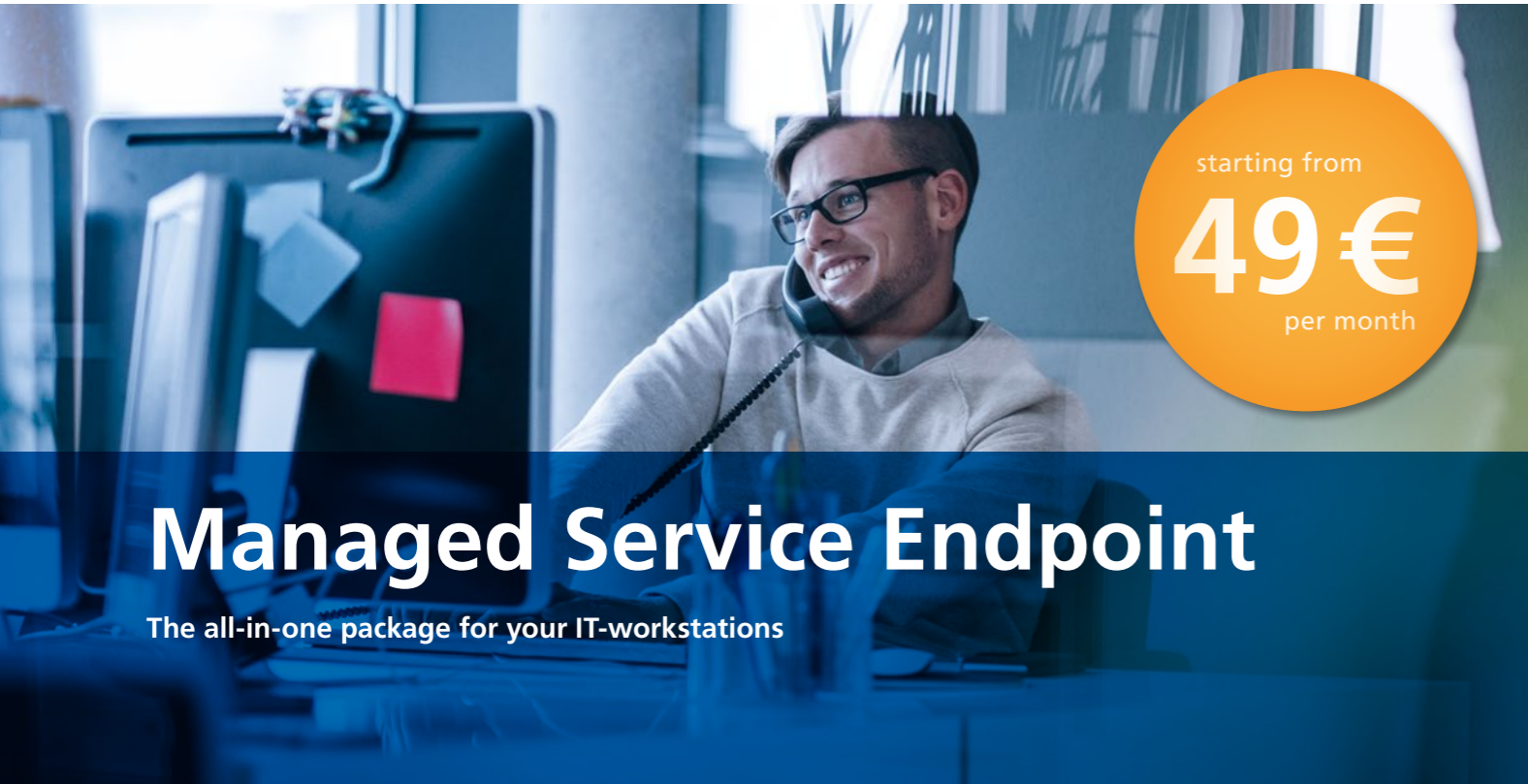

starting from
49€
 per month

Managed Service Endpoint

The all-in-one package for your IT-workstations

Managed Service Endpoint - the all-around solution for your IT-workstations. Your IT-department is relieved of routine tasks and has more time to focus on strategic tasks in day-to-day business. Choose from our modular package the exact services that you need for your environment and standardize the management of your IT-workstations.

All advantages at a glance:

Secure

- No: viruses, malware, extortion
- Instead: protection while browsing, blocking of malicious programs, stopping data thieves

Up-to-Date

- Automatically close security vulnerabilities
- Reliably install manufacturer updates
- Automatic updating of workstations

Maintained

- Installation of new programs
- Provision of new program versions supported

Supported

- Call assistance
- Troubleshooting
- User support

Overview

- Keep an eye on your devices and software
- Automatic detection and documentation of used PCs, laptops and installed programs

Monitored

- Ongoing monitoring of PCs
- Detection of errors and intervention if necessary

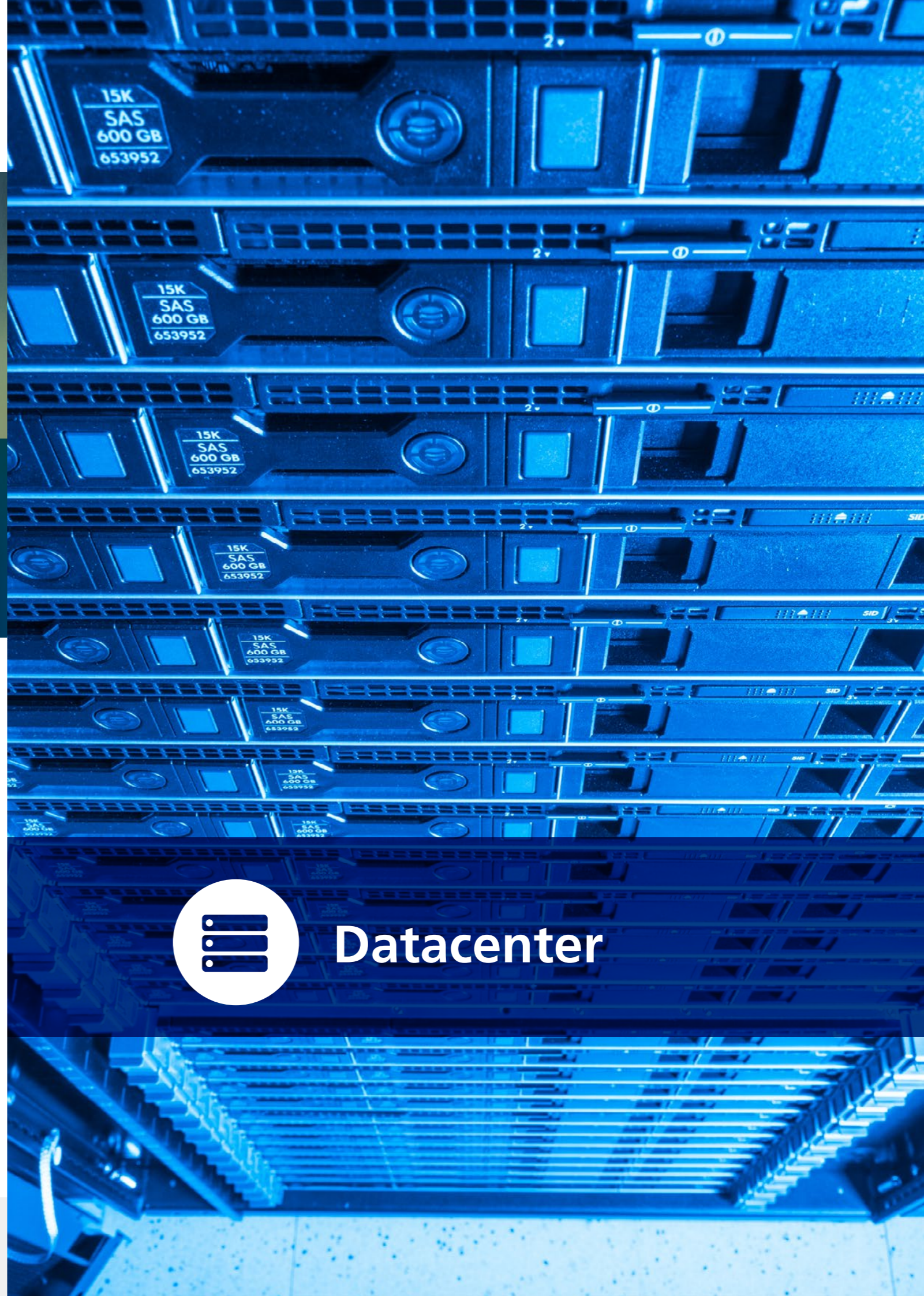

Datacenter



VMware – vSAN 7.0

Software-defined Storage for a future-oriented architecture

VMware NSX

Network virtualization and security platform for software-defined data centers

What is VMware vSAN 7.0?

vSAN is a software-defined storage solution from VMware that can provide a strategic and economic advantage. It forms the basis for a hyperconverged infrastructure (HCI), which is a software-based architecture that runs on industry-standard x86 servers and components through the close collaboration of computing, networking, and shared storage. This allows for a predictable, risk-free building of a data center with the ability to be prepared for future requirements at any time.

For all critically virtualized workloads, vSAN offers flash-optimized, secure shared storage that is centrally managed (just as the entire solution) through the proven vSphere user interface.

Furthermore, vSAN 7.0 offers a completely new, explicitly hybrid cloud-oriented HCI experience with higher operational efficiency. The user interface impresses with proactive support information and thus provides the basis for consistent performance and availability of applications.

Hyper-Converged Infrastructure – Powered by VMware vSAN

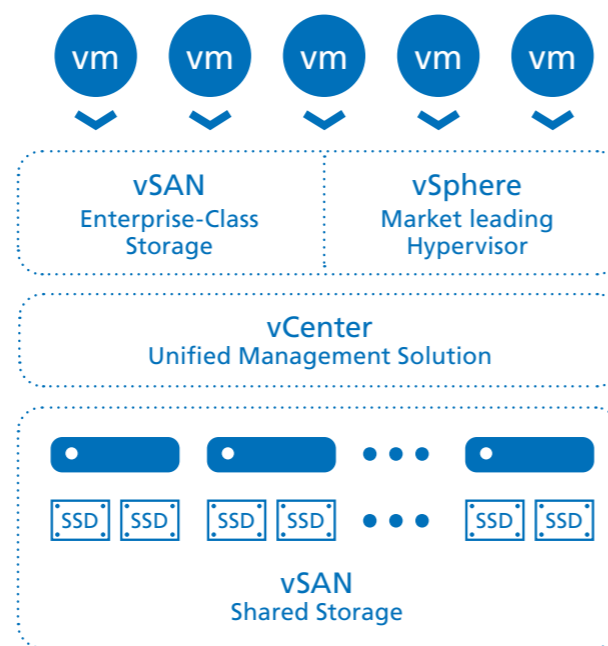

What is NSX?

VMware NSX is a network virtualization and security platform for a software-defined data center (SDDC). It applies the operational model of a virtual machine to entire networks.

By integrating switching, routing, and firewalling into the hypervisor, these network functions can be utilized throughout the environment, creating a type of network hypervisor. As an operator of one or more data centers, you can benefit from increased agility, security, and cost-effectiveness through the implementation of NSX networks as software.

Virtual networks can be provisioned seamlessly on existing network hardware.

Benefits of NSX

- High security even on individual workloads
- Network deployments in seconds
- Ensuring security and network service through partnerships with leading third-party providers

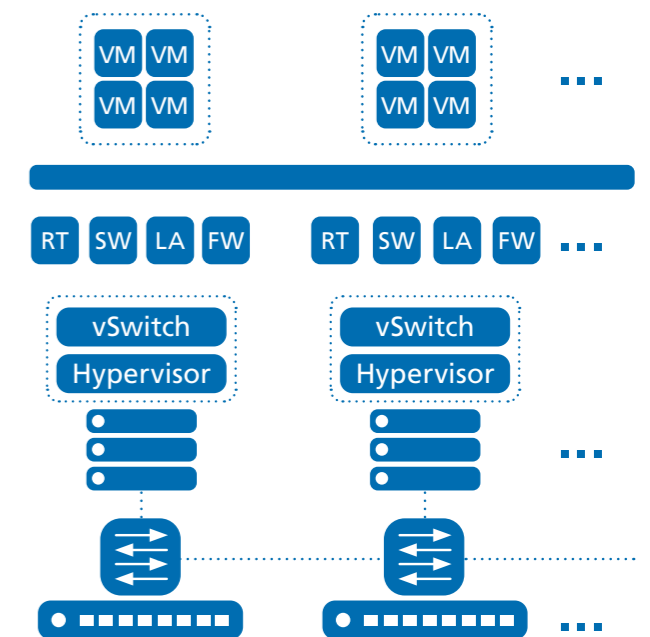

Managed Kubernetes

Managed Kubernetes (K8s) is a future-oriented container orchestration solution

Containers provide a solution to a common problem in IT operations: operating software reliably and consistently, regardless of the deployment target.

Before containers, virtual machines (VMs) were the primary method used to run multiple isolated applications on a single server. VMs require a host with an operating system and a hypervisor that provides access to the host's resources. The VMs, on which many applications and services are provided for different business processes, also require a guest operating system.

Containers, on the other hand, do not require their own operating system. The container engine provides access to the host operating system's kernel. Containers provide individually executable, independent microservices. Each service can be set up, implemented, scaled, and renewed separately. This method has the advantage that containers can be quickly deployed, started, and stopped. If more capacity is needed for a service, new containers are provided. Conversely, containers can be deleted immediately when they are no longer needed.



Read more

Object Storage as a Service

Quick access to large amounts of data - flexible, scalable and secure

The constant increase in unstructured data poses a challenge for companies to adapt to new types of data storage and access. Our Object Storage as a Service provides modern, effective, and highly scalable solutions, either from the CompanyCloud or from the PublicCloud.

Object storage is the solution to better and more organized large amounts of unstructured data. Unlike file storage or block storage, files are stored in a flat structure as objects in a large storage pool and can be easily and quickly retrieved.

Access to your data is through S3 access points, each using the REST API over HTTPS. You will receive your access data in the form of a DNS hostname and a password. Your data can be uploaded and downloaded via SSL-encrypted endpoints, and access rights can be defined individually.

Storage solutions compared



Block Storage

Data is stored as „blocks“ of fixed size in a rigid arrangement - ideal for corporate databases



File Storage

Data is stored as „files“ in hierarchically nested „folders“ - ideal for active documents



Object Storage

Data is stored as „objects“ in scalable „buckets“ - ideal for large, unstructured data, analytics, and archiving



Read more

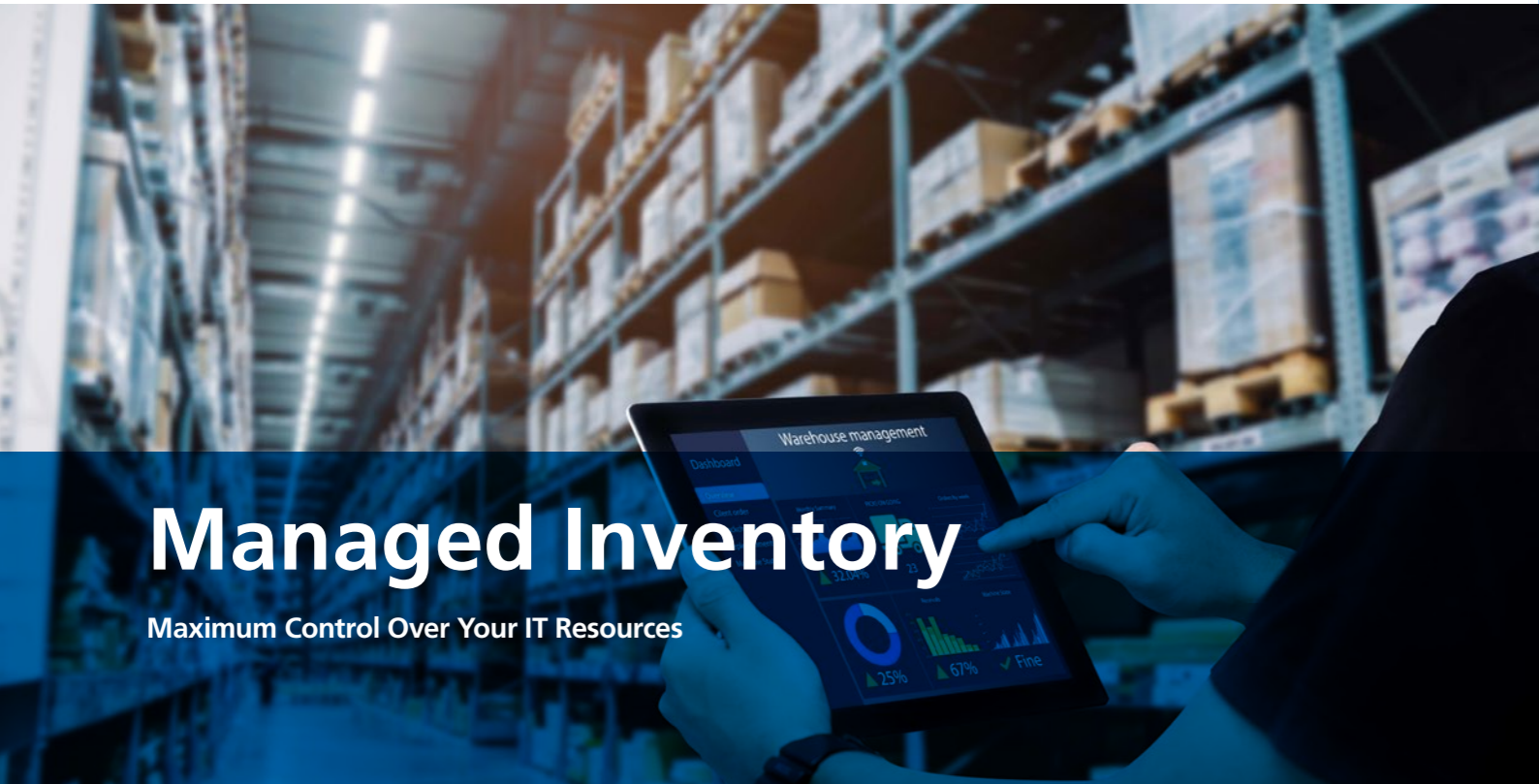

Managed Inventory

Maximum Control Over Your IT Resources

In rapidly growing business environments where new devices and licenses are continually needed, and employee numbers are constantly on the rise, it can be challenging to keep track. However, precise IT documentation and inventory management are essential to ensure smooth operations. This is where Managed Inventory comes into play – an innovative solution that significantly reduces administrative efforts, allowing you to focus on your core tasks. Discover how Managed Inventory enhances efficiency, transparency, and control over your IT infrastructure, leading to improved performance and cost optimization.

Why You Need Managed Inventory:

- **Are you taking too long to complete a comprehensive hardware inventory?** We digitize and automate up to 80% of hardware inventory, allowing us to conduct a full IT inventory within a few days.
- **You want to rely on very high data quality?** With our Managed Inventory, you minimize the risk of inaccurate data and incorrect conclusions. Automatically captured assets are precisely documented, with unrecorded assets being the only uncertainty. Depend on reliable data for well-informed decisions.
- **Do you want automatic IT documentation without much effort?** Without Managed Inventory, creating a professional and comprehensive IT documentation is a full-time job. With our Managed Inventory, you can save yourself this effort and receive reports automatically.
- **Do you need a foundation for IT security concepts?** We regularly generate audited reports. These audited reports ensure that due diligence has been performed. Responsible authorities can thus, for example, verify that all production systems are up-to-date with the latest security patches.



Modern Workplace





Backup for Microsoft Office 365 Applications

Complete control, faster access and comprehensive protection for your Office 365 data.

Microsoft provides powerful services with Office 365. But what about their backup? With Backup for Microsoft Office 365, you benefit from maximum control and fast access to your Exchange, SharePoint, OneDrive, and Teams applications - only then are your data really safe and always available.

Why do I need a backup for my Office 365 data?

Due to the infrastructure provided by Microsoft, Office 365 provides data access from anywhere and at any time, without the need to set up your own infrastructure for emails, files, or SharePoint. The data belongs to you, you have control, and are therefore responsible for protecting it.

Microsoft Office 365 backups can be securely stored in any location

With Backup for Microsoft Office 365, you are not bound to a specific target system for storing your data. You decide whether to back up your Office 365 SharePoint objects, emails, and files on local systems or cloud-based object storage.

Your benefits at a glance:

- Comprehensive protection of your Office 365 data from accidental deletion, security threats, and gaps in retention policies
- Minimal time and effort for searching and restoring individual Office 365 objects and files
- Increased security while adhering to compliance guidelines through multi-factor authentication



Read more



Administration (AaaS) and monitoring (MaaS) of Microsoft 365 applications

Professional administration and monitoring of your IT environment

You want to ensure the continuity of your business processes? Our Administration and Monitoring „as a Service“ approach starts right here.

We simplify your daily work. Our Administration as a Service (AaaS) and Monitoring as a Service (MaaS) services offer comprehensive management and monitoring of Microsoft 365 solutions. This ensures that connected services and applications function properly. Our AaaS and MaaS concepts include tracking, notification, and reporting on usage, performance, and availability, as well as error detection and resolution of Microsoft 365 for Exchange, SharePoint, Skype, OneDrive, and Teams.

Administration - what we do:

- User management (users and groups)
- License management (assign and modify)
- Permission management for Exchange
- Domain management (up to 5 domains)
- Creation of regular software reports in various formats. These provide an ideal basis for analysis and decisions

Monitoring - what we do:

- Measure usage and load
- License monitoring
- Ensure software compliance
- Evaluate software usage
- Uncover unused licenses and under-licensed products



Read more



Medialine UEM Mobile

Many devices. Few clicks. One solution.



Medialine Unified Endpoint Management

With Medialine UEM as a managed service, you can easily, efficiently and securely manage all devices and applications

With Medialine UEM Mobile, you can easily and securely manage mobile devices without burdening your IT resources. Rely on more than 20 years of experience and a management solution that is characterized by ease of use and scalability.

Integrated and user-friendly

Enterprise Mobility Management is a core component of Medialine Unified Endpoint Management. The best-practice solution is based on over 20 years of experience and is available both as a standalone management for mobile devices and in combination with a comprehensive system management for all AD-managed devices as Unified Endpoint Management. As a managed service in the Medialine AG data centers, we offer you a comprehensive solution for your device management, which combines the simplest administration on a central console with the highest security requirements.

Challenges in device management

Many management solutions are rich in features but are optimized for operation by IT administrators due to their complexity and lack of user-friendliness. This poses challenges for companies of all sizes as IT resources are scarce and costly. Especially in heterogeneous teams and companies with many locations, different requirements, and diverse processes, bottlenecks in device management quickly arise. Medialine UEM Mobile is the only mobile device solution that is so easy and intuitive to use, despite its high functional scope and compliance requirements, that no IT resources are needed, and administration can be easily managed by the management or HR department.

Any Place, any Time, any Device!

Endpoint management is becoming increasingly complex due to the growing number of functions, processes, device diversity, compliance, rights structures, and geographical requirements. The efficient integration of end devices into various work processes has become a strategic competitive advantage. Modern companies now use a variety of devices to work in a need-based, efficient, cost-effective, and flexible manner. The commissioning and operation of this infrastructure is challenging and time-consuming.

UEM as a Managed Service

Inadequate usability and user-friendliness, along with security and compliance aspects, are major challenges for many companies in endpoint management. With Medialine UEM as a managed service, you can easily and securely manage your devices and roles on a central, managed platform in the data centers of Medialine AG. Through intelligent process mapping, the underlying software automatically gathers all relevant information using smart scripts and the so-called „abstraction layer.“ This means that no IT resources are needed for management. Required work steps are executed with a mouse click and a complex technology becomes a simple and user-friendly environment that automates all important business processes.

The path to the Modern Workplace

With Unified Endpoint Management, companies can take the step towards the Modern Workplace today! The unique integration of AD-managed devices and non-AD-managed devices on a central platform makes application, device, and security management truly easy and clear. You can manage your stationary devices, Fat Clients, User-Roles and -Rights as well as your Mobile Devices or IoT instances automatically and easily. This includes classic system management functions such as Asset Management, Patch Management, Image and Software Distribution, and Mobility Management functions such as File Sharing or Mobile Deployment. Additional endpoint solutions (e.g., IoT Management) can be integrated into the flexible management appliance as needed. This way Medialine UEM grows with your company and its requirements.



WiFi as a Service

Professional management of your WLAN IT infrastructure

In today's world, the availability of a reliable wireless network has become a matter of course. Whether it's for employees or visitors, access to their data, emails, and websites should function smoothly and securely. Our WiFi as a Service includes the management, monitoring, and optimization of your entire WLAN IT infrastructure for one or multiple locations.

What we offer you

- Software-based installation and maintenance of the entire WiFi network
- Monitoring of backend components
- Provision of the WiFi network for internal employees and guests
- Individual expansion of access points
- Hardware for access points included in the monthly fee
- Variable service contract terms of one or three years
- Central voucher system including personalized portal for your WiFi guests
- Cross-location configuration
- Airtime fairness for large client environments
- Band steering for high performance
- Security through VLAN support



Cloud Computing



SAP on CompanyCloud

Optimize and transform your SAP Landscape

CompanyCloud Self Service Portal

The Medialine CompanyCloud Self Service Portal allows you to easily and directly orchestrate your Infrastructure-as-a-Service services - at the push of a button and without waiting times.

SAP users have long known that support for traditional SAP core systems will be discontinued in just a few years. The migration of the current databases to HANA and a switch to S/4 is unavoidable and offers opportunities.

In the future, SAP is set to rely entirely on the cloud, leading many users to ask themselves the following questions:

- Can I manage the migration without loss of efficiency?
- How secure is the cloud?
- Can I run SAP in compliance with GDPR in the cloud?

Learn how you can take full advantage of SAP from the cloud!

Together with Telekom Deutschland GmbH and the certified SAP service provider Consolut GmbH, Medialine will accompany you in the complete process of migrating your SAP systems to the CompanyCloud. From consultation and design to implementation and SAP hosting, an expert team is available to you.

SAP on CompanyCloud opens up new worlds

Together with the Medialine Dataport, which, as a carrier and cloud-neutral infrastructure solution, enables direct connection to partners, clouds or locations, the CompanyCloud forms the basis of the new SAP solution. This provides an infrastructure that guarantees high performance and security standards and creates the basis for high-quality SAP hosting. Medialine also offers secure backup solutions and, if required, comprehensive monitoring of the services used. The different locations of the data centers in Frankfurt, Bad Sobernheim and Hamburg also ensure geo-redundant security of the data and services.

Is your company growing or are the demands on your infrastructure changing? Do you need a flexible model to always be able to provide the right service? This is no problem with the Infrastructure Self Service from the CompanyCloud:

You can book virtual machines with just a few clicks via your administration access or switch off those that are no longer required. The virtual resources (such as CPU, RAM, operating system) can be put together individually or can be accessed as a firmly defined standard.

Benefits at a glance:

Time saving

Easy request of resources and immediate provision

Flexibility

Scale services easily and use them immediately

Control

View all related services at a glance in the Service Portal

Pay-as-you-go

Only pay for what you really need

Cost saving

Avoid stockpiling resources and idle time and benefit from efficient resource use

No investment costs

Only pay your monthly quota and avoid high start-up costs

Plannable

Make IT costs efficient and calculable

Secure

Benefit from modern security standards at the enterprise level

Highest quality

The automated setup of virtual machines reduces misconfigurations

Automated cost center assignment

Smooth billing and cost control





Managed Mail Archive

Revision-proof email archiving „as-a-service“

We offer our Managed Mail archive to customers in Germany and Austria in compliance with legal requirements within german data centers.

Many companies archive their emails on paper, on mail servers, or through manual backups, but manual processes increase the likelihood of errors and make it more difficult to comply with legal requirements. Storage must be provably unmodified and immutable for a period of up to 30 years to ensure revision-proofing. Don't take the risk and use the automated service of Medialine AG.

Securely backup your emails - easily and revision-proofly

On the technological basis of MailStore Server, we offer the following features:

- Archiving of all incoming and outgoing emails
- Archiving of internal emails
- Fast access to archived emails
- Fully automatic without user intervention
- Easy and fast integration into your existing email system

- Secure data exchange with the customer network
- Operation in redundant, secure data centers in Germany
- Compliance with country-specific legal requirements and data protection standards

You can also use the add-in for Microsoft Outlook or the web access for mobile devices.

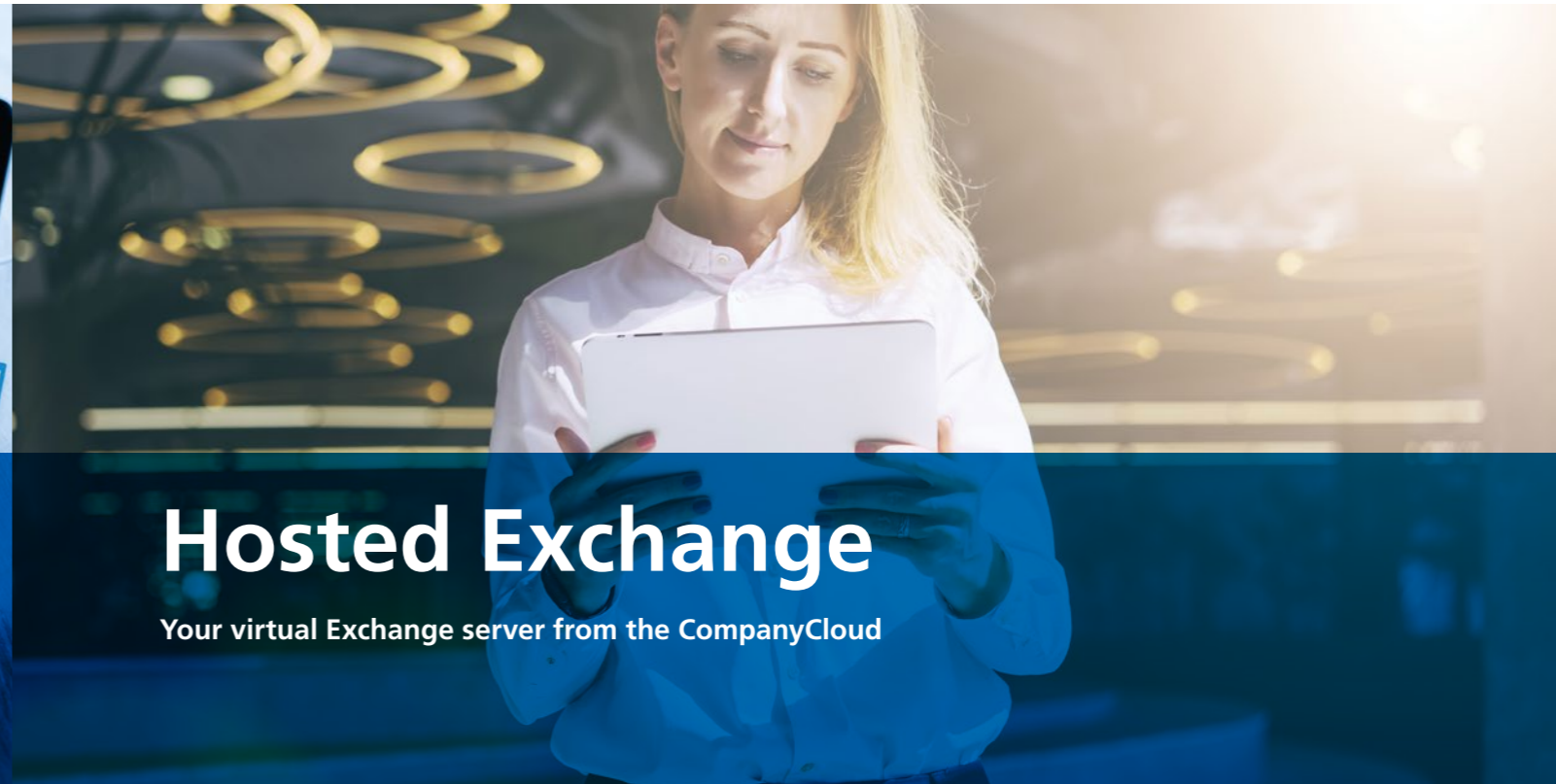

Hosted Exchange

Your virtual Exchange server from the CompanyCloud

Hosted Exchange offers you the full functionality of Microsoft® Exchange Server in combination with the advantages of a virtual solution. Synchronize your communication on various clients and improve team communication without costly investments in your own hardware and software. This can be done as a Public or Private Cloud solution.

Features of the Medialine VMX Server:

Email Inbox

- Up to 25 GB of storage space

OWA (Outlook Web Access)

- Includes certificate-based SSL encryption
- Option for 30-day individual mail restore
- Integrated virus and spam protection
- Backup of the inbox

Public Folder

- 1 GB of free storage space
- Comfortable networking of data (such as contacts, appointments, and tasks)
- Creation of your own group calendars, scheduling appointments, and task distribution

Smartphone/Tablet Integration

- Use Hosted Exchange on your mobile device regardless of the platform





DataPort

Secure Multicarrier IP Services on one port. Your direct way as a Cloud Hub to all networks.



Azure Peering in Medialine Dataport

Connectivity on the next level

DataPort is carrier- and cloud-neutral, allowing customers to connect (to partners, clouds, locations) through one port without the need for multiple carriers as a direct connection, increasing security and saving costs.

Internet Access

Direct, redundant connection to three internet carriers. Peering at DE-CIX, the largest German exchange node. Dedicated port or shared port with bandwidth.

IP-Access

Connection with preferred access to the Eyeball network of Deutsche Telekom (AS 3320) as well as connections to one of the largest internet exchange nodes in Europe and to other Tier-1 carriers.

Features:

- Internet connections with bandwidths from 20 Mbit/s up to 10 Gbit/s
- Service Level Agreement (SLA)
- IP4/IP6 enabled
- 24/7 monitoring and hotline

IP Transit

Connection to the IP backbone of the data center (AS 205614). Routing of the customer's autonomous system's data based on IP packet forwarding using BGP 4 (Border Gateway Protocol) from and to the customer's IP network in transit through the IP backbone in the data center. The data center's own AS 205614 is highly performant and has preferred access to the Deutsche Telekom's Eyeball network (AS 3320) as well as connections to one of the largest internet exchange nodes in Europe and to other Tier-1 carriers.

Features:

- Internet connection with bandwidths from 100 Mbit/s to 10 Gbit/s.
- BGP-4 default route or full-table route
- Provision of a transfer network (/30 IPv4 or /64 IPv6)
- Service Level Agreement (SLA)
- 24/7 monitoring and hotline

To prioritize important data traffic in the Microsoft Cloud, users need additional services. Our customers benefit from infrastructure advantages here, without incurring additional costs.

The Medialine WAN Backbone offers significant advantages through its connection to the world's largest internet exchange, DE-CIX in Frankfurt am Main. Multiple 10G peerings to various locations ensure highly efficient and fail-safe connections with the lowest possible latency. As a result, Microsoft services such as Azure Peering, which involve additional costs, become obsolete for Medialine customers.

Microsoft services are increasingly in demand in many companies

more and more business-critical workloads are being moved to the Azure cloud. Availability, connectivity, and performance are crucial elements to ensure smooth daily workload operations. To give customers the ability to prioritize their connections, Microsoft offers a special service: the Microsoft Azure Peering

Service (MAPS). This establishes a direct connection between the provider and the customer via a private and dedicated network path. The service supports both IPv4 and IPv6. This does not take the detour through the public infrastructure of the internet and therefore offers higher performance, lower latency, and higher security. However, this results in additional costs.

Your benefits at a glance:

- Highly performant and reliable connection
- Based on EthernetConnect 2.0 and MPLS with guaranteed bandwidths and latencies
- Highest security standards



Boxxer ERP

With the flexible merchandise management solution for businesses, gastronomy and retail, you can efficiently optimize your resources - starting from the first user!

Boxxer ERP (Enterprise Resource Planning) manages your company's processes as well as the data of your business partners, products, operations, and evaluations easily and clearly.

Manage processes efficiently

Boxxer is an enterprise software specifically designed to meet the needs of small and medium-sized businesses and can be used as a POS cash register software, merchandise management and service billing program, as well as an ERP. It is particularly distinguished by its well-integrated interfaces to marketplaces, payment systems, and Office 365. Boxxer can be implemented in businesses of any industry, but is especially suitable for retailers, service providers, online shops, marketplaces, and small producers, serving a wide range of business forms.

Overview of Boxxer:

- for small and medium-sized businesses
- 1 to 25 users
- multi-client capable
- open for interfaces
- Main industries/sectors are trade, service providers, online shops, marketplaces, and small-scale production

Boxxer POS

Boxxer WaWi

Boxxer Enterprise



Business Software



Boxxer POS

Boxxer POS - The Smart Point of Sale System for Small and Medium-sized Businesses

Mesonic WinLine

Flexible ERP and CRM systems for your business success

Fast and competent customer service at the Point of Sale (PoS), both in gastronomy and in retail, is a crucial element for success. By integrating the Boxxer POS system with your ERP system, you simplify sales and payment processes.

Boxxer POS System

The Boxxer POS system can be used as a single-user version on a computerized cash register but is also available as a complete system configuration in a cash register network. The POS system can be used in any industry as product and group management is based on its own database.

By adding licenses, the POS system can easily be expanded into a full-fledged ERP program. Boxxer has no problem assigning property obligations. For example, industry-specific properties such as allergens can be associated with a product and displayed on the label or similar.

Additionally, Boxxer enables the integration of your online ordering system with the POS system. With Boxxer POS, „click and collect“ offers can be easily implemented. In addition, customer cards, discount promotions, postal code recording, and coupon models can be easily integrated.

Product Management, Category Management, and Favorites

With the Boxxer POS system, product and category management is unlimited. User-friendly operation is emphasized, allowing individual categories (depending on the industry module) to be selected as separate buttons below the favorites. Using a quick input function (scanner supported), an article number can be entered including a quantity input. An additional import function for a larger number of articles simplifies the article creation process.

Small and medium-sized businesses need flexible, practical systems that can be perfectly adapted to their company size. Together with Medialine and Mesonic, create your tailored solution and optimize your business processes.

Mesonic is the expert for customized business software solutions for small and medium-sized enterprises. With over 40 years of experience and more than 60,000 successfully installed software solutions in over 20 countries, Mesonic is the ideal partner for your company. Automate and optimize your business processes and benefit from the unique flexibility of Mesonic's ERP and CRM systems. The various software offerings of Mesonic WinLine adapt to the requirements of your company and can be individually designed for you through various functional modules and additional tools. Medialine is your competent partner for selecting and implementing the right tools for your business. Together with you, we dive into your requirements and processes to be able to efficiently and accurately map them.

Our ERP and CRM systems:

Mesonic Business

- Modular structure
- For all areas of business
- Maximum flexibility
- Tailored to your requirements
- Easy conversion to WinLine corporate possible

Mesonic Corporate

- Maximum scope of features
- Exclusive functions
- Low all-inclusive price





WinLine/cop Integration

The integrated industry solution for IT-system houses

The WinLine/cop interface integrates the cop purchasing platform and the WinLine ERP system into a complete industry solution for IT-system houses.

The cop agent integrated in WinLine enables you to efficiently conduct market research. With a large number of suppliers, you can research prices and products and order them immediately if necessary. The deep integration in WinLine allows you to create and update product data without much effort, send orders online, and retrieve the status of your order from the supplier.

Product data always up-to-date

All products available through cop are available. Daily prices and availability can be taken into account when creating/purchasing the item.

Create quotes quickly and securely

All products available through cop are available. Daily prices and availability can be taken into account when creating/purchasing the item. Quotes always consider daily prices and availability.

Efficient article creation

The product becomes a logistics-relevant article when the order is placed and is available with all current data for ordering and delivery.

Smarter purchasing

The best current source of supply is determined, ensuring that the best possible margin can be achieved. The selection of possible suppliers can be limited to suppliers already entered in Winline.

Funktionsübersicht:

- Product search
- Price comparison
- Takeover of articles in offer / order
- Article creation with data transfer
- Constantly updated product information
- Selection of the best source in the ordering process

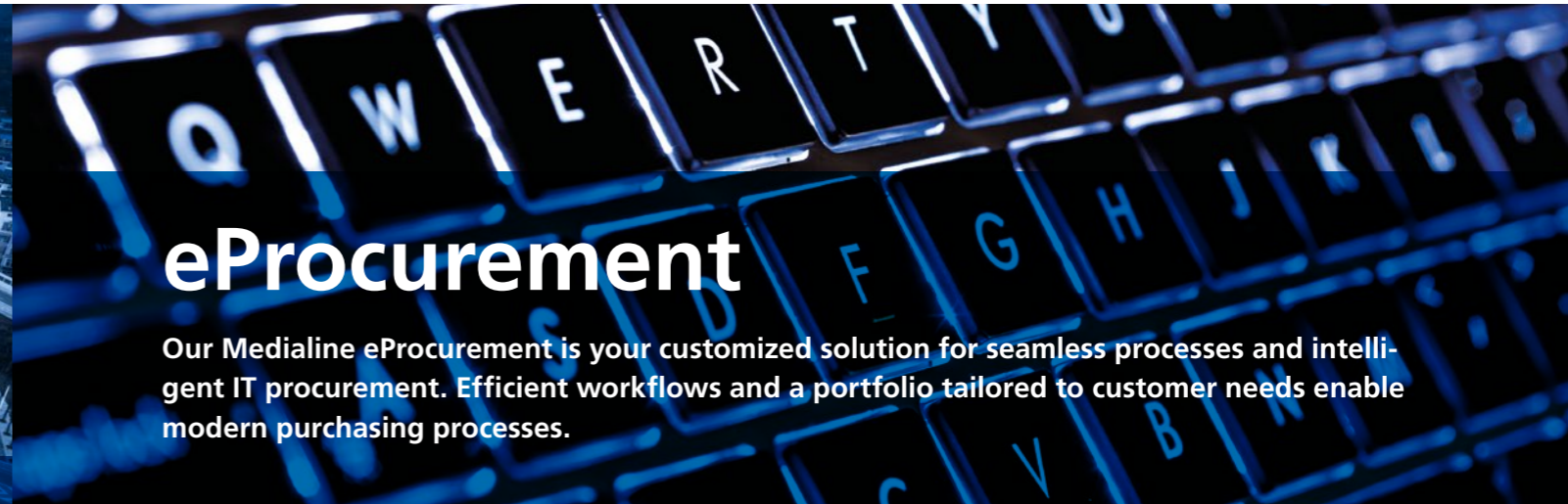

eProcurement

Our Medialine eProcurement is your customized solution for seamless processes and intelligent IT procurement. Efficient workflows and a portfolio tailored to customer needs enable modern purchasing processes.

Our eProcurement system offers you the opportunity to process the entire IT procurement online via the Medialine AG shop portal or to directly connect an individual shop portal to your IT. In either case, you have full flexibility in designing the IT offering for you and your employees in our online shop. Integration with your own ERP system via an OCI interface also offers the possibility to trigger orders internally, including integration with financial accounting and invoice processing. Optimize your workflow, save time and resources, and gain guaranteed traceable and transparent order reporting through electronic procurement.



Portfolio

One shop – 250,000 products, covering all IT product needs in one place



Resources

Time savings through automated processes and traceable, transparent order reporting



Workflow

Simplified ordering through pre-configured products and integration of authorization structures



Individuality

Customizable product portfolio tailored to companies and accounts



Best Price

Live querying always shows the cheapest available price



International

Procurement for and by European corporate locations and subsidiaries is possible



ERP-Integration

Optimized resource planning through full integration of the shop into your company's ERP via OCI interface



Best Buy

Integrierter Produktvergleich unterstützt Ihre Kaufentscheidung



ITK SIP-Trunk

Crystal clear communication: Our flexible SIP trunk for your needs!

The ITK SIP trunk enables real-time communication via the IP network. Numerous phone numbers and voice channels are provided via a central ITK SIP trunk, whether national or international. The individually scalable ITK SIP trunk enables the provision of national and international service numbers, booking & merging of international numbers, as well as the takeover of own numbers. The number of voice channels required can be adjusted at any time.

Thanks to vendor-independent consulting, you use exactly the ITK SIP trunk that is adapted to your needs. The redundant multi-carrier ITK SIP trunks are provided from the ITK Communications high-security data centers or installed on your premises.

Your benefits:

- Number provision
- Number porting
- International numbers bookable & mergeable
- Worldwide service numbers
- Flexible rate options
- High flexibility: scalable voice channels
- Redundancy concepts
- Local breakouts



Unified Communications





ITK Teams Solution

Your Microsoft Teams client with telephony features from the ITK Cloud

The unique ITK Teams Solution combines telephony and other cloud services around Microsoft Teams in one solution.

Connect Microsoft Teams with extensive telephony functions, such as integration of DECT systems, analog hardware, contact center, recording, attendant console, monitoring. The focus is also on the integration of CRM, ERP systems and other databases.

Your benefits

- Telephony via Microsoft Teams
- No additional hardware required
- Cross-site integration of national & international SIP trunks/call numbers
- Connection options for your analog endpoints incl. existing IP & DECT telephones
- Various native integrations (e.g. contact center, switchboard, recording, etc.)
- Simple & flexible pricing model
- One contact person for your entire Teams interface



Microsoft Teams Solution

Your Microsoft Teams client with telephony features from the ITK Cloud

Teams Contact Center

The Contact Center with Teams Attendant is the ideal complement to your Teams client. As a native integration, it enables smooth lead management and creates a fully comprehensive coordination of your contacts.

- Visueller Workflow-Editor
- Live-Dashboards
- IVRs
- Reporting
- Auto Attendants
- CRM-, ERP- & Ticketing-Tool Integration
- Öffnungszeiten
- Text-to-Speech Funktion
- u.v.m.

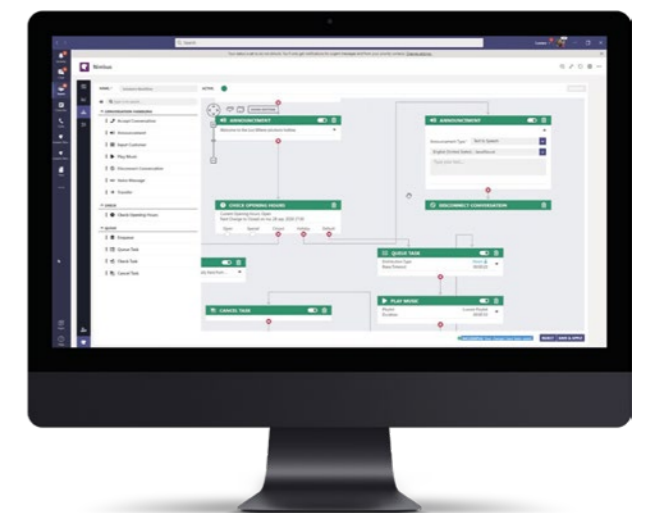



Microsoft Teams Consulting

Consulting services for Microsoft Teams from certified experts

ITK Communications offers a comprehensive consulting program for the successful and sustainable introduction of Microsoft Teams in your company.

The consulting program is made up of coordinated modules.

Module 1: Business Decision Maker Workshops

- Introduction of leadership/pilot team to Microsoft Teams, including live demo
- Best practice examples
- Security & compliance

Module 2: Network Workshops

- General introduction to networking for Microsoft Teams
- Security & compliance
- Network analysis & evaluation
- Creation of a measures and recommendations catalog

Module 3: Admin Training

- Introduction to administration für Microsoft Teams
- Security & compliance
- User management, authentication & access rights
- External tools (e.g. Power BI)

Module 4: Teams Adoption Workshops

- Training of product champions
- Basics of Microsoft Teams
- Process mapping & process help

Module 5: User Training

- Introduction to Microsoft Teams, including live demo
- Communication via Microsoft Teams
- Handling external guests
- Terminals

Module 6: Change Management Workshop

- Digital transformation
- PROSCI Risk-Assessment
- ADKAR-Model



ITK Presence Hub

A synchronized presence status across your entire communication structure.

Call routing in your PBX system is based on the presence status of the users. Calls should only be forwarded to available users. However, if you use two communication platforms, the presence status between the two platforms must be synchronized. With the ITK Presence Hub, your Microsoft Teams presence status can be synchronized with that of your PBX system. The ITK Presence Hub is a cloud service that can be seamlessly integrated into your Microsoft Teams tenant.

Your benefits

- Bidirectional presence status synchronization between Microsoft Teams and PBX system
- Aggregation of the presence status of both systems
- Central SaaS solution
- No installation required on the clients
- Real-time notification of status changes
- No polling of status information
- User-based licensing model independent of the total number of users





Cloud Telephone Systems

Cloud Telephone Systems

Medialine provides tailored communication solutions from the cloud for every business size, need, and requirement.

Modern telephone systems are no longer static in your company's premises but come easily, flexibly, and securely from our three German high-security data centers.

The modular structure and relocation of telephony with all features to our data centers allow you to add or remove desired services on a monthly basis.

The great advantage over other cloud solutions lies in the diverse selection of various CTI, contact center, and mobility solutions, as well as the integration and control of ERP and CRM systems.

ADDITIONAL BENEFITS

- Easy implementation, administration & configuration
- Full integration of Microsoft Teams including telephone functions
- Efficient collaboration
- Encrypted data and calls
- ISDN voice quality
- Making calls via Softphone on the PC
- Simple budget planning, easy pricing model & transparent costs per workstation
- Scalable extensions and maximum flexibility of services per workstation
- Always up-to-date, with updates and quality optimizations running in the background
- Highest level of reliability through multiple system redundancies
- Integration and control of ERP & CRM systems



Video conference rooms & -systems

Video conference rooms & systems

Whether it's meetings, conferences, or conventions: we offer complete conference room solutions, equipped with suitable lighting, state-of-the-art media technology, and exclusive furniture. Customizable to room size and budget, of course, but always including service and maintenance.

The different standard models are available in different price ranges (Basic, Comfort, Premium).

Additionally, we also provide conference rooms for ad-hoc meetings and small discussions (Meeting Points, Huddle Think Tanks, and more).

We can find your individual solution for virtual meetings.

A selection of standard models

- Meeting Room (up to 10 people)
- Conference Room (up to 12 people)
- Boardroom (up to 20 people)



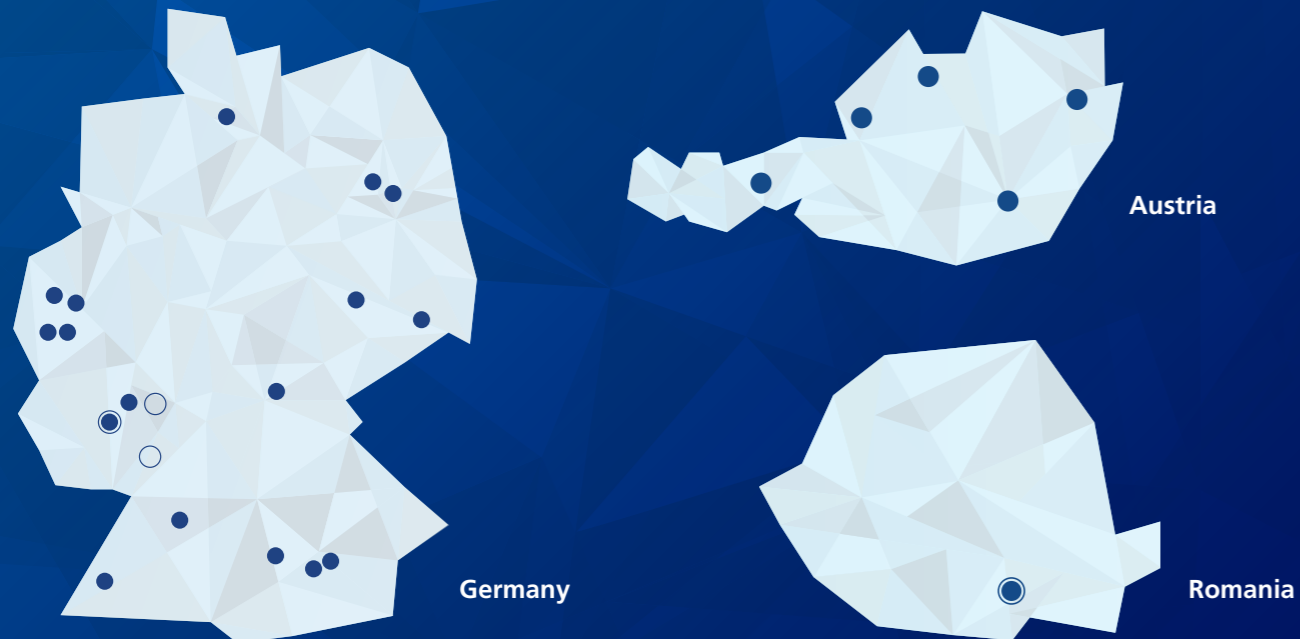

Welcome to the Medialine Group!

As a full-service provider, we offer companies comprehensive IT and telecommunications solutions. With our guiding principle of **ANY PLACE - ANY TIME - ANY DEVICE - ANY APPLICATION**, we see it as our task to be a guide, companion, and trusted advisor for our customers on their individual path of digitalization. To do this, we support them from needs

analysis through conception and process optimization to implementation, support, and documentation of complex systems. As a group, we pursue the same goals and stand together for our values but remain independent companies that complement each other perfectly.

Our locations in Europe

With a dense network of locations and our redundant data centers, we support our customers with consistent high-quality service on-site. Our international locations in Austria and Romania ensure the familiar Medialine quality across national borders. Together, the companies of the Medialine Group are successfully active in the market to be able to offer customers holistic IT solutions from a single source.

Germany

Headquarter Bad Sobernheim Breitlerstraße 43 55566 Bad Sobernheim	Augsburg Berlin Adlershof Berlin Charlottenburg Coburg Dornach Dresden	Duesseldorf Frankfurt Freiburg Hamburg Cologne Deutz Cologne Vogelsang	Leipzig Munich Rhein-Neckar Stuttgart Wiesbaden Wuppertal
--	---	---	--

Austria

Graz Innsbruck	Linz Salzburg	Vienna
-------------------	------------------	--------

Romania

Bucharest

By choosing us, you can rely on:

- Future-proof architecture
- Innovative solutions
- Individualized consulting
- Stable platforms
- Technical know-how clusters
- A strong network

Regional proximity is a crucial success factor for us to maintain good customer relationships. At the same time, our customers benefit from our extensive network and nationwide orientation, which provides access to comprehensive technology and sales resources. From our own data centers in Germany, Austria, and Romania, we provide a complete portfolio of Managed IT Services with our product, CompanyCloud.

Numerous awards and accolades confirm the high quality of our solutions and recognize us as one of the most innovative companies in the German medium-sized business sector. Strong partnerships with renowned manufacturers and highly specialized expert teams make us the right service provider for the challenges our customers face.



as of: 08/2023



www.medialine.com/en
www.group.medialine.com/en
welcome@medialine.com
Tel.: +49 6751 85378 0

